

METRÓPOLIS P60X60EUGR9

40W LED panel 60x60
UGR < 19



HIGH EFFICIENCY
110 lm/W



GARANTÍA



HIGH QUALITY



CRI > 90



FLICKER FREE

SPECIFICATIONS · PRODUCT DATA

| Electrical data | |
|--|--|
| Input | 220 ~ 240Vac |
| Mains frequency | 50/60Hz |
| Power | 40W |
| Power factor | > 0,95 |
| LEDs n° | 108 chips |
| LED power | 0,37W |
| IEC protection class | Class II |
| Photometric data | |
| Luminous efficiency | 110 lm/W |
| CRI (Ra) | >90 |
| Luminous lux (Nominal / Real) CCT | 5200 lm · 4400 lm · 6000K · BF 5120 lm · 4280 lm · 4000K · BN |
| Luminous intensity | 1895 cd |
| SDCM Standard deviation colour adjustment | <3 |
| Degree of opening | 120° |
| Working Temp. | -20°C ~ +40°C |
| Switchovers n° | 30.000 |
| Certifications | CE, RoHS |
| Energy efficiency | A+ |
| Working life | 50.000 h (L70B50) |
| Materials and physical characteristics | |
| Frame | Aluminum alloy |
| Diffuser | PMMA |
| Finish | White RAL 9016 |
| Measurements in mm (length x width x height) | 595 X 595 X 10 |
| Weight (g) | 2800 |
| Characteristics | |
| IP Rating | IP40 IP44 Optional |
| IK Rating | IK03 |
| UGR Rating | <19 |
| Flicker | No |
| Options | |
| Dimming option | Optional (see option table) |
| Control option | RF Optional (MDRF) BT Optional (MDBT) |
| Emergency kit option | Optional (KEU503) Optional (KEU2403) |
| Sensor movement option | Optional (SL20) |
| Packaging | |
| Packaging measurements | 695 X 665 X 250 |
| Packaging weight (kg) | 15,5 |
| Units (units/box) | 5 units |

Measurements in mm

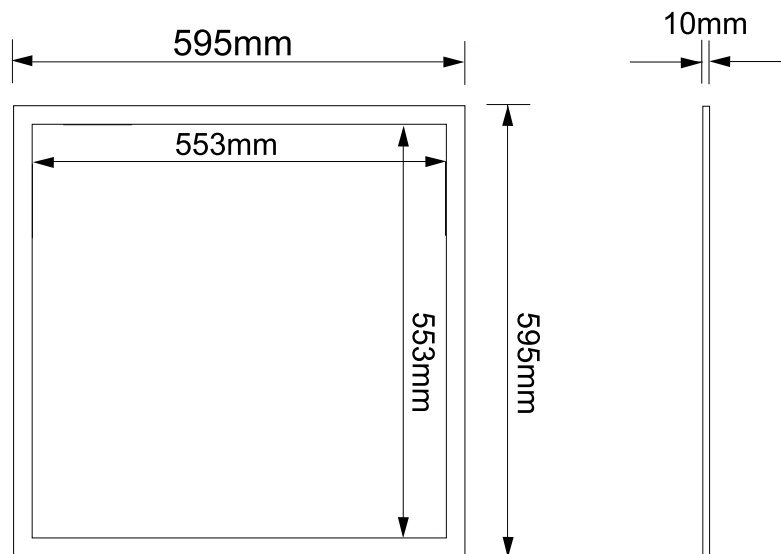



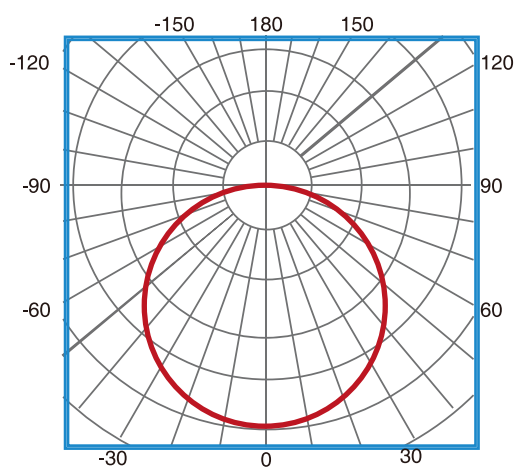

Optics

Beam angle 120°

| H (m) | Diámetro (m) | E _{max} (lx) |
|-------|--------------|-----------------------|
| 1 | 1,92 | 1895 |
| 2 | 3,85 | 474 |
| 3 | 5,77 | 211 |
| 4 | 7,70 | 119 |



References

|  |  | W |  |  |  | CCT | CRI |
|---|---|------|---|---|---|-----------|------|
| P60X60EUGR9BF | RAL 9016 | 40 W | 5200 lm | 4400 lm | 120° | BF: 6000K | > 90 |
| P60X60EUGR9BN | RAL 9016 | 40 W | 5120 lm | 4280 lm | 120° | BN: 4000K | > 90 |

Dimming options

|  | Dimming |
|---|------------------------------------|
| DM | 0/1-10V dimming and button dimming |
| DA | DALI Dimming |

When choosing dimming option, please complete your reference with the code.

Installation

Surface installation options

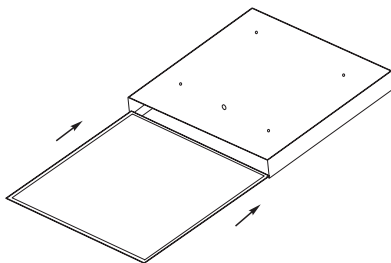

ASC60X60
600x600 panel surface case kit

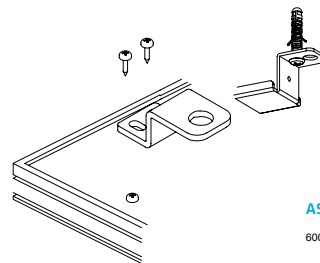

ASE60X60
600x600 panel surface brackets kit

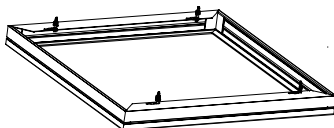

ASM60X60V2
600x600 panel surface frame kit

Recessed installation options

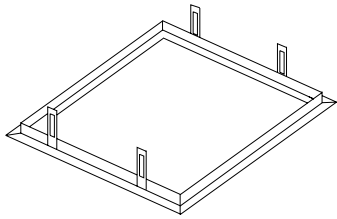

AEM60X60

600x600 panel recessed frame kit

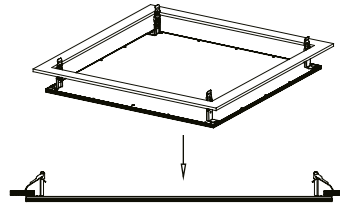

ASP60X60

600x600 panel recessed retrofit clips kit

Suspension installation options

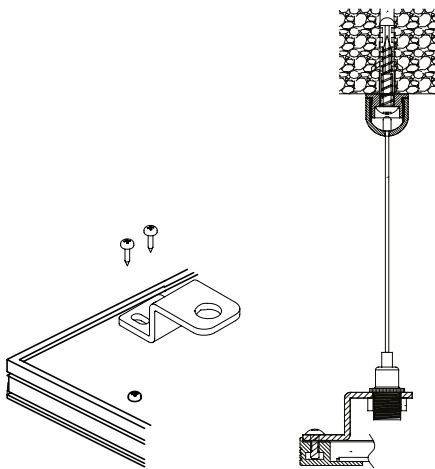

A560X60

600x600 panel suspension accessory

